

DIN 41612 / IEC 60603-2 Female Connectors New Design

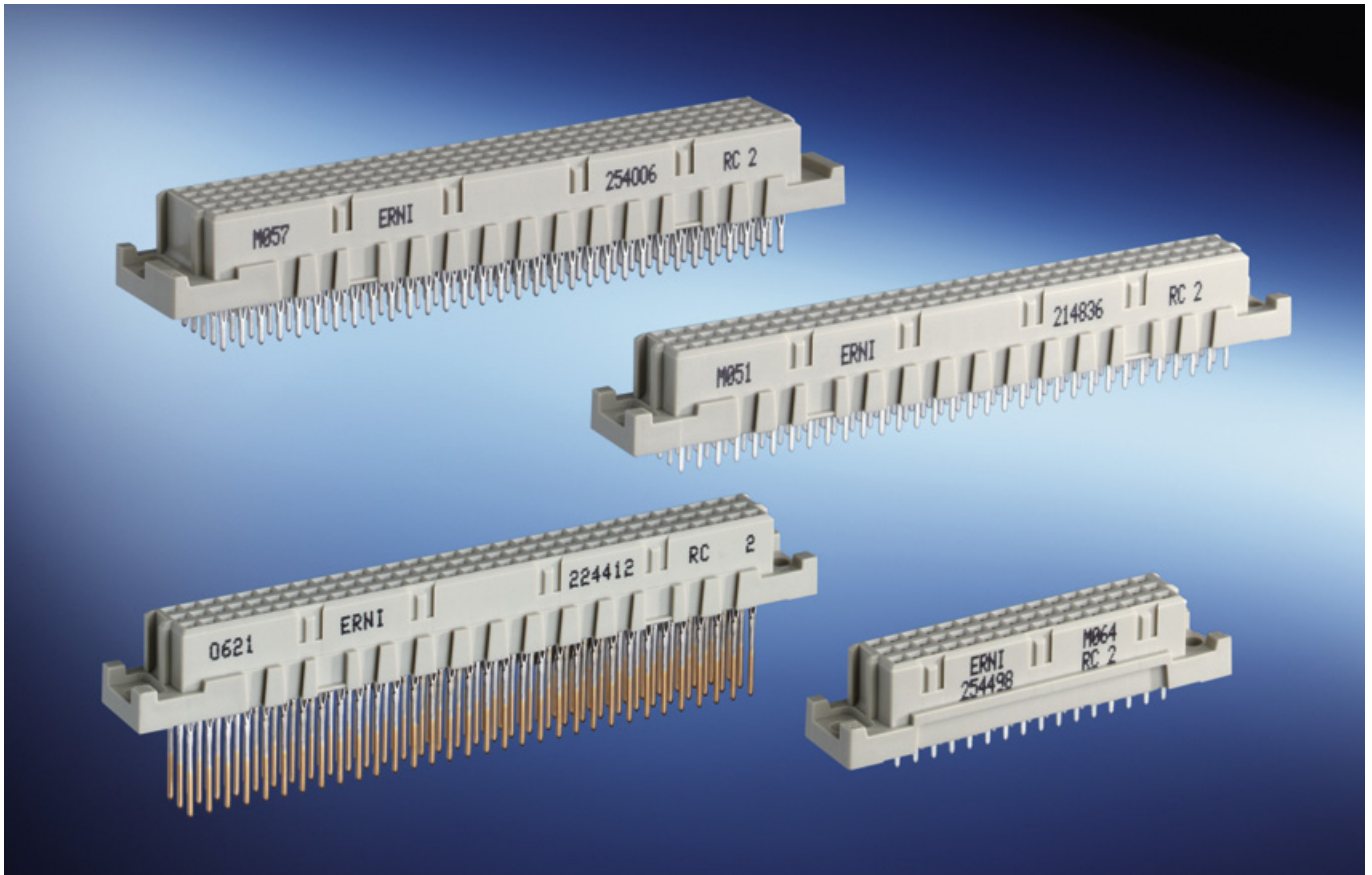

ERNI introduces a new design of its female DIN connectors. The new design offers the following advantages:

- Reduction of press-in force by approx. 25%, using the new „Eye of the Needle“ pressfit zone. This leads to lesser strain towards the PCB.
- 100% controlled quality of the pins due to consequent usage of Automated Optical Inspection during the manufacturing process.
- Partial and mixed loading possible.
Available termination lengths:
Solder: 2.5 mm; 3.7 mm; 4.0 mm; 13.0 mm; 17.0 mm
Pressfit: 2.9 mm; 4.0 mm; 5.5 mm; 13.0 mm w. Transfer Zone; 17.0 mm w. Transfer Zone
Wire Wrap: 13.0 mm; 17.0 mm
- Dimensions of insulation bodies remain unchanged for backwards compatibility.
- Fixation clip or retaining loop for efficient mounting of the connector when soldering is selectable in all positions.
- Solder stop versions, preventing a rising of the solder up into the housing, available on request for type B and C connectors.
- Transfer zone contacts are selectable for all versions.
- A simple coding mechanism, by using coding strips, is standard on all type B, C, E and CD connectors.
- The THR versions are made of a high temperature resistant material which makes them suitable for reflow soldering.

With immediate effect the following parts will be converted:

Vertical Female Connectors Type C

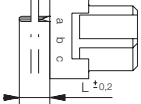
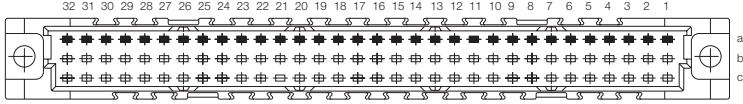
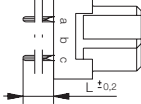
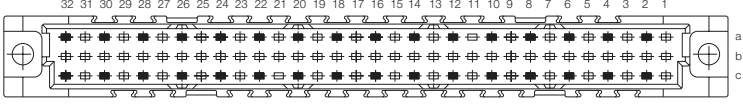
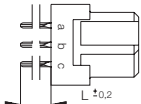
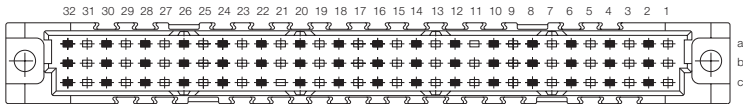
Number of Pins	Termination	Termination Length	Class	Pin Dimensions	Part Number Old Design	Part Number New Design
						
32	Solder	13 mm	2	0.6 x 0.6 mm	543404	244296
						
32	Solder	4 mm	2	0.65 x 0.3 mm	043017*	244265
32	Solder	4 mm	2	0.65 x 0.3 mm	004767	244265
32	Solder with Clip	4 mm	2	0.65 x 0.3 mm	033297	234431
32	Solder	13 mm	2	0.6 x 0.6 mm	543403	244297
32	Solder w. Transfer Zone	13 mm	2	0.6 x 0.6 mm	023337	244298
32	Solder w. Transfer Zone	17 mm	2	0.6 x 0.6 mm	593404	244299
						
48	Solder	2.5 mm	2	0.65 x 0.3 mm	123324	224409
48	Solder with Clip	4 mm	2	0.65 x 0.3 mm	123786	234432
48	Solder	4 mm	2	0.65 x 0.3 mm	033628	284082

* Termination Length: 3.7 mm

** Termination Length: 4.5 mm

*** Termination Length: 2.9 mm

Vertical Female Connectors Type C

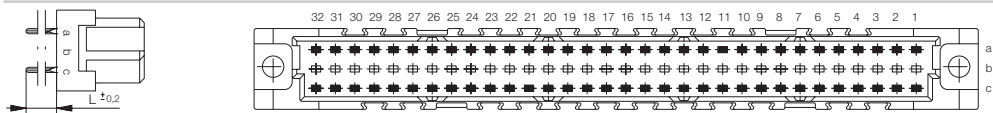
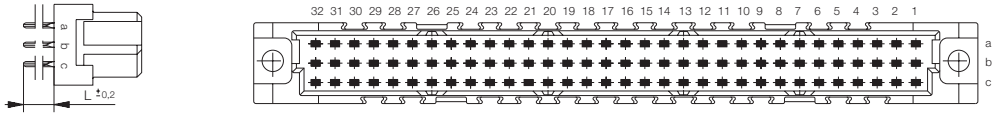
Number of Pins	Termination	Termination Length	Class	Pin Dimensions	Part Number Old Design	Part Number New Design
						
64	Solder w. kinked Legs	2.5 mm	2	0.65 x 0.3 mm	063543	284170
64	Solder	4 mm	2	0.65 x 0.3 mm	594834	224411
64	Solder	4 mm	2	0.65 x 0.3 mm	543407	224411
64	Solder	4 mm	2	0.65 x 0.3 mm	064188**	224411
64	Solder with Clip	4 mm	2	0.65 x 0.3 mm	063727**	224471
64	Solder w/o Flange	4 mm	2	0.65 x 0.3 mm	-	223799
64	Solder	13 mm	2	0.6 x 0.6 mm	543401	244301
64	Solder w. Transfer Zone	13 mm	2	0.6 x 0.6 mm	013962	244302
64	Solder	17 mm	2	0.6 x 0.6 mm	593405	244303
						
96	Solder	2.5 mm	2	0.65 x 0.3 mm	063647***	224470
96	Solder	4 mm	2	0.65 x 0.3 mm	023661*	214836
96	Solder	4 mm	2	0.65 x 0.3 mm	054350**	214836
96	Solder	4 mm	1	0.65 x 0.3 mm	594073	254897
96	Solder	4 mm	2	0.65 x 0.3 mm	594833	234496
96	Solder with Clip	4 mm	2	0.65 x 0.3 mm	033228	224472
96	Solder	13 mm	2	0.6 x 0.6 mm	543402	244304
96	Solder w. Transfer Zone	13 mm	2	0.6 x 0.6 mm	013905	244305
96	Solder w. Transfer Zone	17 mm	2	0.6 x 0.6 mm	593406	244307
96	Solder w. Transfer Zone	17 mm	1	0.6 x 0.6 mm	593443	254931

* Termination Length: 3.7 mm

** Termination Length: 4.5 mm

*** Termination Length: 2.9 mm

Vertical Female Connectors Type C

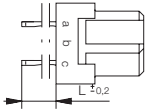
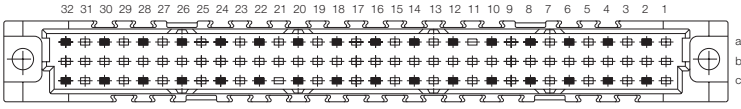
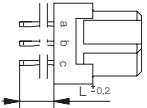
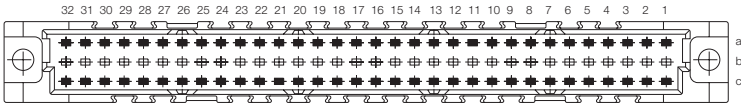
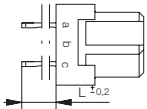
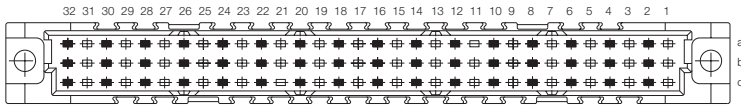
Number of Pins	Termination	Termination Length	Class	Pin Dimensions	Part Number Old Design	Part Number New Design
		5.5 mm	1	0.6 x 0.6 mm	023348	254134
		5.5 mm	2	0.6 x 0.6 mm	043135	254135
		5.5 mm	2	0.6 x 0.6 mm	043124	254136
		5.5 mm	2	0.6 x 0.6 mm	424999	254136
		4 mm	2	0.65 x 0.3 mm	053149*	244268
		4 mm	2	0.65 x 0.3 mm	063232**	244268
		5.5 mm	2	0.6 x 0.6 mm	913133	254137
		5.5 mm	2	0.6 x 0.6 mm	414273	254137
		5.5 mm	2	0.6 x 0.6 mm	913660	254851
		13 mm	2	0.6 x 0.6 mm	023397	244126
		17 mm	2	0.6 x 0.6 mm	913134	224410
		17 mm	2	0.6 x 0.6 mm	593272	244410

* Termination Length: 3.7 mm

** Termination Length: 4.5 mm

*** Termination Length: 2.9 mm

Vertical Female Connectors Type C

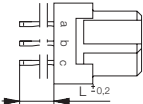
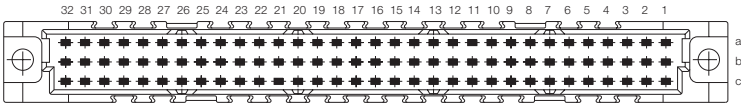
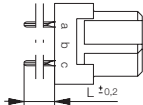
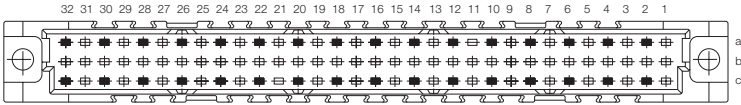
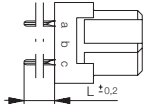
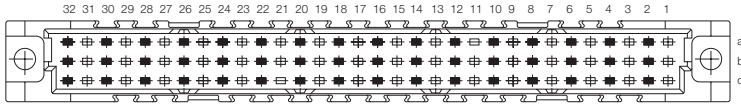
Number of Pins	Termination	Termination Length	Class	Pin Dimensions	Part Number Old Design	Part Number New Design
						
96	Pressfit	2.9 mm	2	0.65 x 0.3 mm	063512	254117
96	Pressfit	4 mm	2	0.65 x 0.3 mm	053595**	204752
96	Pressfit	5.5 mm	1	0.6 x 0.6 mm	013159	254015
96	Pressfit	5.5 mm	1	0.6 x 0.6 mm	004365	254015
96	Pressfit w/o Flange	5.5 mm	1	0.6 x 0.6 mm	103691	254849
96	Pressfit w/o Flange	5.5 mm	2	0.6 x 0.6 mm	033109	254850
96	Pressfit	5.5 mm	2	0.6 x 0.6 mm	913110	224408
96	Pressfit	5.5 mm	2	0.6 x 0.6 mm	414437	224408
96	Pressfit w. Transfer Zone	13 mm	2	0.6 x 0.6 mm	063570	224412
96	Pressfit w. Transfer Zone	13 mm	2	0.6 x 0.6 mm	013964	224412
96	Pressfit w. Transfer Zone	13 mm	1	0.6 x 0.6 mm	013808	284135
96	Pressfit w. Transfer Zone	17 mm	1	0.6 x 0.6 mm	593274	254931
96	Pressfit w. Transfer Zone	17 mm	1	0.6 x 0.6 mm	023387	254931
96	Pressfit w. Transfer Zone	17 mm	2	0.6 x 0.6 mm	913135	244295
						
32	THR	2.5 mm	2	0.6 x 0.6 mm	-	224477
						
64	THR	2.5 mm	2	0.6 x 0.6 mm	164945***	224475
64	THR w/o Flange	4 mm	2	0.6 x 0.6 mm	-	223801

* Termination Length: 3.7 mm

** Termination Length: 4.5 mm

*** Termination Length: 2.9 mm

Vertical Female Connectors Type C

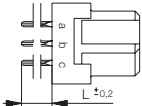
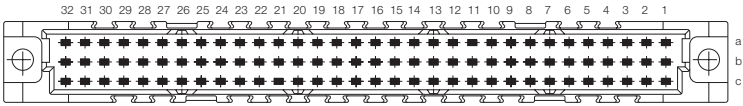
Number of Pins	Termination	Termination Length	Class	Pin Dimensions	Part Number Old Design	Part Number New Design
						
96	THR	2.5 mm	1	0.6 x 0.6 mm	144743***	224473

Vertical Female Connectors Type C/2

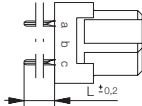
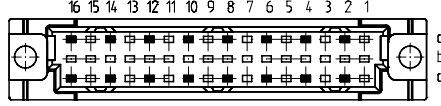
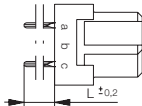
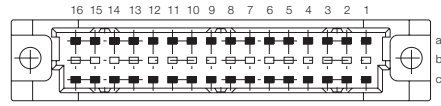
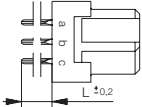
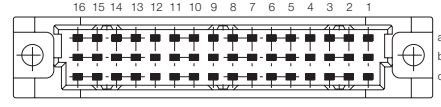







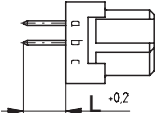
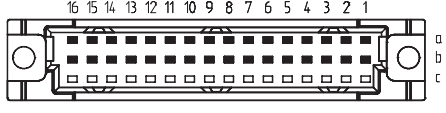
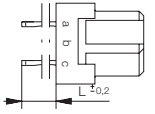
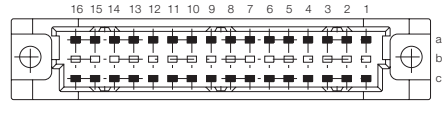
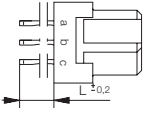
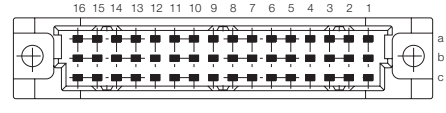

Number of Pins	Termination	Termination Length	Class	Pin Dimensions	Part Number Old Design	Part Number New Design
						
16	Solder	4 mm	2	0.65 x 0.3 mm	033633	254892
						
32	Solder	2.5 mm	2	0.65 x 0.3 mm	004816	254893
32	Solder	4 mm	2	0.65 x 0.3 mm	594086	284171
						
48	Solder	2.5 mm	2	0.65 x 0.3 mm	003442	254498
48	Solder	4 mm	2	0.65 x 0.3 mm	913620*	284174
48	Solder w/o Flange	4 mm	2	0.65 x 0.3 mm	943224*	284175
48	Solder	4 mm	1	0.65 x 0.3 mm	594082	254895
48	Solder	13 mm	2	0.6 x 0.6 mm	413957	284172

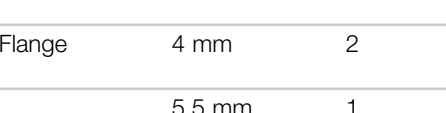
* Termination Length: 3.7 mm

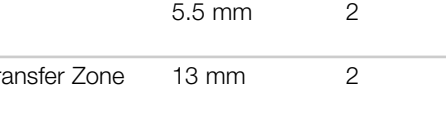
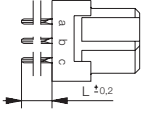
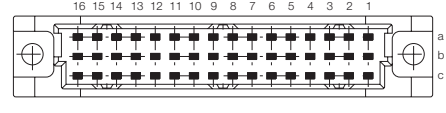
** Termination Length: 4.5 mm

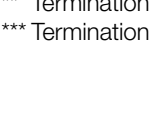
*** Termination Length: 2.9 mm

Vertical Female Connectors Type C/2

Number of Pins	Termination	Termination Length	Class	Pin Dimensions	Part Number Old Design	Part Number New Design
		5.5 mm	2	0.6 x 0.6 mm	123310	254855
32	Pressfit	5.5 mm	2	0.6 x 0.6 mm		
		5.5 mm	2	0.6 x 0.6 mm	913654	254854
32	Pressfit	5.5 mm	2	0.6 x 0.6 mm		
		2.9 mm	2	0.65 x 0.3 mm	-	254926
48	Pressfit	2.9 mm	2	0.65 x 0.3 mm		
		4 mm	2	0.65 x 0.3 mm	043566*	254887
48	Pressfit	4 mm	2	0.65 x 0.3 mm		
		4 mm	2	0.65 x 0.3 mm	053788*	254894
48	Pressfit w/o Flange	4 mm	2	0.65 x 0.3 mm		
		5.5 mm	1	0.6 x 0.6 mm	123094	254852
48	Pressfit	5.5 mm	1	0.6 x 0.6 mm		
		5.5 mm	1	0.6 x 0.6 mm	414369	254852
48	Pressfit	5.5 mm	1	0.6 x 0.6 mm		
		5.5 mm	2	0.6 x 0.6 mm	023761	234647
48	Pressfit	5.5 mm	2	0.6 x 0.6 mm		
		13 mm	2	0.6 x 0.6 mm	043499	284136
48	Pressfit w. Transfer Zone	13 mm	2	0.6 x 0.6 mm		
		17 mm	2	0.6 x 0.6 mm	033547	254896
48	Pressfit w. Transfer Zone	17 mm	2	0.6 x 0.6 mm		
		2.5 mm	2	0.6 x 0.6 mm	144711	254970
48	THR with Clip	2.5 mm	2	0.6 x 0.6 mm		

* Termination Length: 3.7 mm

** Termination Length: 4.5 mm

*** Termination Length: 2.9 mm

Vertical Female Connectors Type C/3

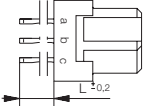
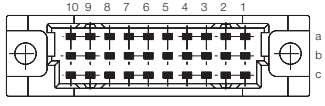
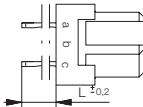
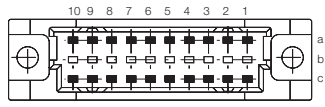
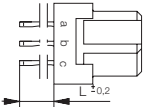
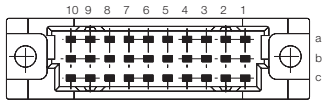





Number of Pins	Termination	Termination Length	Class	Pin Dimensions	Part Number Old Design	Part Number New Design
						
30	Solder	2.5 mm	2	0.65 x 0.3 mm	004791	244336
30	Solder	4 mm	2	0.65 x 0.3 mm	004492	254320
30	Solder	4 mm	1	0.65 x 0.3 mm	004491	254891
30	Solder	13 mm	2	0.6 x 0.6 mm	424186	284173
						
20	Pressfit	5.5 mm	2	0.6 x 0.6 mm	043592	254838
						
30	Pressfit	4 mm	2	0.65 x 0.3 mm	063310*	254995
30	Pressfit	5.5 mm	2	0.6 x 0.6 mm	033120	254836
30	Pressfit w/o Flange	5.5 mm	2	0.6 x 0.6 mm	043131	254321
30	Pressfit w. Transfer Zone	13 mm	2	0.6 x 0.6 mm	043414	284176

* Termination Length: 3.7 mm

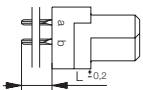
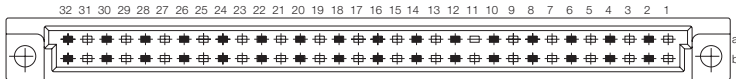
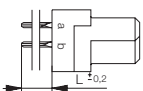
** Termination Length: 4.5 mm

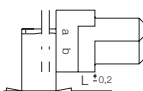
*** Termination Length: 2.9 mm

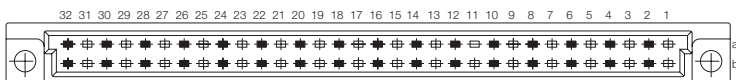
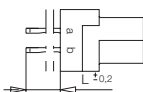
Vertical Female Connectors Type B

Number of Pins	Termination	Termination Length	Class	Pin Dimensions	Part Number Old Design	Part Number New Design
						
						
32	Solder	4 mm	2	0.65 x 0.3 mm	033617	284164
						
						
64	Solder	4 mm	2	0.65 x 0.3 mm	594080	284166
64	Solder	13 mm	2	0.6 x 0.6 mm	543412	284165
						
						
32	Pressfit	5.5 mm	2	0.6 x 0.6 mm	023107	254848
						
						
32	Pressfit	5.5 mm	2	0.6 x 0.6 mm	043175	254847
						
						
64	Pressfit	4 mm	2	0.65 x 0.3 mm	043073*	254994
64	Pressfit	5.5 mm	2	0.6 x 0.6 mm	023108	254846
64	Pressfit w/o Flange	5.5 mm	2	0.6 x 0.6 mm	043543	254878
64	Pressfit	5.5 mm	1	0.6 x 0.6 mm	023367	284178
64	Pressfit w. Transfer Zone	17 mm	2	0.6 x 0.6 mm	023372	284179

* Termination Length: 3.7 mm



** Termination Length: 4.5 mm

*** Termination Length: 2.9 mm

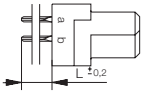
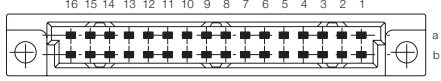
Vertical Female Connectors Type B/2

Number of Pins	Termination	Termination Length	Class	Pin Dimensions	Part Number Old Design	Part Number New Design
						
32	Solder	4 mm	2	0.65 x 0.3 mm	594089	284168
32	Solder	13 mm	2	0.6 x 0.6 mm	414290	284167

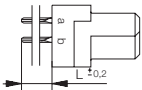
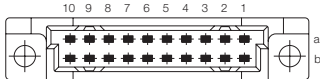
Vertical Female Connectors Type B/3

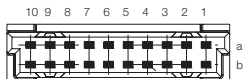
Number of Pins	Termination	Termination Length	Class	Pin Dimensions	Part Number Old Design	Part Number New Design
						
20	Solder	4 mm	2	0.65 x 0.3 mm	004487	254370
20	Solder	13 mm	2	0.6 x 0.6 mm	424204	284169
						
20	Pressfit w/o Flange	5.5 mm	2	0.6 x 0.6 mm	433765	234449

* Termination Length: 3.7 mm
 ** Termination Length: 4.5 mm
 *** Termination Length: 2.9 mm

Vertical Female Connectors Type CD

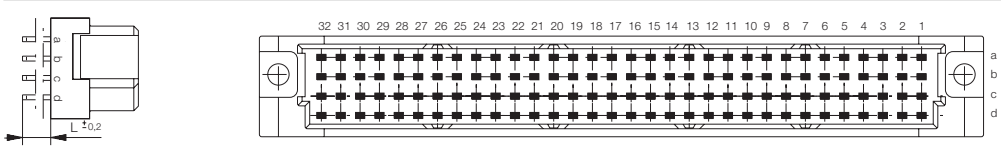
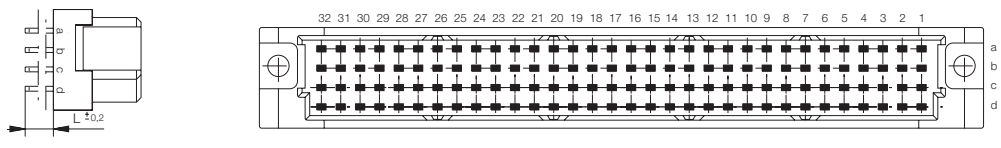
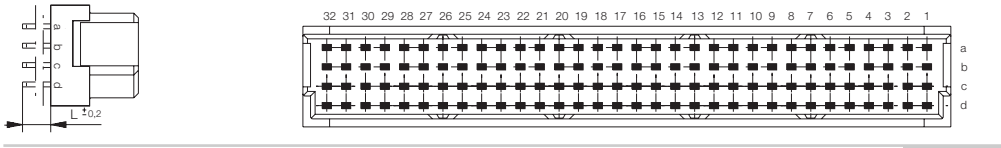
Number of Pins	Termination	Termination Length	Class	Pin Dimensions	Part Number Old Design	Part Number New Design
						
128	Solder	4 mm	1	0.65 x 0.3 mm	033299*	284182
128	Solder	4 mm	2	0.65 x 0.3 mm	023762*	254977
128	Solder w/o Flange	4 mm	2	0.65 x 0.3 mm	024412*	284180
128	Solder with Clip	4 mm	2	0.65 x 0.3 mm	063426*	254978
						
128	Pressfit	5.5 mm	1	0.6 x 0.6 mm	913658	254843
128	Pressfit w/o Flange	5.5 mm	2	0.6 x 0.6 mm	023742	254844
128	Pressfit	5.5 mm	2	0.6 x 0.6 mm	033035	244999
128	Pressfit w. Transfer Zone	13 mm	2	0.6 x 0.6 mm	033223	254979
128	Pressfit w. Transfer Zone	17 mm	2	0.6 x 0.6 mm	033104	284181
						
128	THR w/o Flange	2.5 mm	2	0.6 x 0.6 mm	144714	284183

* Termination Length: 3.7 mm

** Termination Length: 4.5 mm

*** Termination Length: 2.9 mm

Vertical Female Connectors Type E160

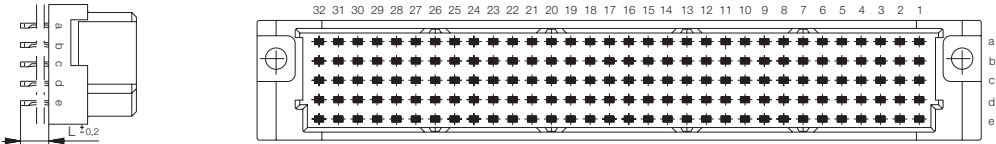
Number of Pins	Termination	Termination Length	Class	Pin Dimensions	Part Number Old Design	Part Number New Design
						
160	Pressfit w/o Flange	5.5 mm	2	0.6 x 0.6 mm	043068	254840
160	Pressfit	5.5 mm	2	0.6 x 0.6 mm	004885	254006
160	Pressfit	5.5 mm	1	0.6 x 0.6 mm	023406	254839
160	Pressfit w. Transfer Zone	13 mm	1	0.6 x 0.6 mm	023407	284185
160	Pressfit w. Transfer Zone	13 mm	2	0.6 x 0.6 mm	013315	254975
160	Pressfit w. Transfer Zone	17 mm	2	0.6 x 0.6 mm	004887	254960
160	Pressfit w. Transfer Zone	17 mm	1	0.6 x 0.6 mm	023405	284184

* Termination Length: 3.7 mm
 ** Termination Length: 4.5 mm
 *** Termination Length: 2.9 mm